



Operating & Display Unit

URB 2



CANopen

EN
English

Original Installation Instructions
818601-03

Contents

Page

Important Notes

Usage for the intended purpose.....	5
Safety note.....	5
ATEX (Atmosphère Explosible)	5
Note on the Declaration of Conformity / Declaration by the Manufacturer CE	5

Explanatory Notes

Scope of supply	5
Description.....	5
Function.....	6

Technical Data

URB 2	7
Name plate / marking	7
Dimensions.....	8

Installation

URB 2	9
-------------	---

Functional Elements

URB 2	9
Key	10

Electrical Connection

Control cable.....	11
CAN bus voltage supply.....	12
Wiring the connecting sockets.....	12
Wiring the sensor connectors.....	13
Wiring diagram for CAN bus system – example –.....	13

Basic Settings

Bus cable.....	14
Factory setting	14
Establishing / changing node ID	14
Node ID.....	15

Operation

User interface	16
Menus.....	17
Specification of keys and navigation wheel	18
Specification of the symbol bar	18
Menu structure	19

Menu Start

Start logo	20
Start.....	20
Language.....	21
System configuration	21
Baud rate	22
Brightness.....	22
About URB 2.....	23
Service menu.....	23
Service – Lock URB	23
Service – Unlock URB	24
Service – Key test	25

Menu Control

At a glance.....	25
Control	26
Overview.....	27
Status report	28
Sensitivity	29
Measuring range	29
Switchpoints	30
Switchpoints, proportional range	31
Actual value output 4-20 mA.....	31
Switching times	32
Control valve	33
Control parameters	34
Temperature	34
Continuous blowdown valve	35
MIN / Blowdown.....	36

Menu Limiter

Limiter	37
Control unit	38
Limiter Bx	38
Testing the limiter	38

Contents - continued -

Page

System Malfunctions

Causes.....	39
Systematic malfunction analysis	40
Restart.....	41
Status messages.....	42

Decommissioning

URB 2	43
Disposal.....	43

Glossary.....	44
----------------------	-----------

Important Notes

Usage for the intended purpose

The operating & display unit URB 2 may only be used in conjunction with GESTRA CAN bus devices. Any type of use differing from the usage described above must be considered as improper. The resulting risk will have to be borne by the user alone. The manufacturer hereby expressly rejects any claims for any damage resulting from improper usage.

Safety note

The equipment must only be installed and commissioned by qualified and competent staff. Retrofitting- and maintenance work must only be performed by qualified staff who – through adequate training – have achieved a recognised level of competence.



Attention

The name plate specifies the technical features of the equipment. Note that any item of equipment without its specific name plate must neither be commissioned nor operated.

ATEX (Atmosphère Explosible)

According to the European Directive 2014/34/EU the equipment must **not** be used in explosion-risk areas.

Note on the Declaration of Conformity / Declaration by the Manufacturer CE

For details on the conformity assessment according to the European Directives see our Declaration of Conformity or our Declaration of Manufacturer.

The current Declaration of Conformity / Declaration of Manufacturer are available in the Internet under www.gestra.de/document or can be requested from us.

Explanatory Notes

Scope of supply

URB 2

- 1 Operating & display unit URB 2
- 1 Connector socket M 12, with 5 poles, A-coded
- 1 Connector socket M12, with 5 poles, A-coded, with terminating resistor 120 Ω
- 1 Installation manual
- 1 Sticker with password

Description

The URB 2 is an operating & display unit for all GESTRA CAN bus devices that uses the CANopen protocol to register all the data telegrams coming from the sensors, control units and actuators that are provided by the CAN bus.

The following readings, parameters and settings can be displayed and – with the exception of the actual values – also be changed by means of the URB 2.

Explanatory Notes - continued -

Description - continued -

	Level	Conductivity	Temperature
Actual value bar chart	X		
Actual value, numerical	X	X	X
MIN limit	X	X	X
MAX limit	X	X	X
Switchpoints	X	X	X
Relay (de)energizing times	X	X	
Actual value output 4 - 20 mA			X
Measuring range	X	X	
Setpoint	X	X	X
Control parameters	X	X	
Valve position of level control valve	X		
Unit [μ S/cm or ppm]		X	
Stand-by		X	
Continuous blowdown valve Operating position of the valve		X	
Purging pulse 24 h		X	
Blowdown duration		X	
Pulse interval		X	
Intermittent blowdown interval		X	
Duration of intermittent blowdown		X	
Manual/Automatic operation	X	X	

Function

The operating & display unit URB 2 evaluates at regular intervals the data telegrams of all sensors, controllers and actuators in a CAN bus system.

The readings, parameters, settings and messages are indicated in plain text. When used as second water level indicator in boiler plants (TRD 401, EN 12952 / ...53), the level is also indicated in the form of a bar graph.

Several languages can be selected for plain text display.

The password protection prevents unauthorized persons from changing parameters and settings.

If other menu levels are selected via the start window and neither a button nor the navigation wheel is then actuated, the operating & display unit URB 2 will automatically return to the start window after 5 minutes. The time-out function is not effective during manual operation or in the parameterization mode.

The help function in the various operating levels offers additional information on how to operate the equipment.

Technical Data

URB 2

Input / output

CAN bus interface with power supply 18-36 V DC, short circuit protected

Data exchange

CAN bus to ISO 11898, CANopen protocol

Indicators and adjustors

1 Graphics display, resolution 320 x 240 pixels, illuminated

4 Buttons

1 Rotary switch with integrated push-button (navigation wheel)

Wiring

2 Connector sockets M12, with 5 poles, A-coded

Power consumption

5.2 VA

Protection

Front panel: IP 54 to EN 60529

Back: IP 10 to EN 60529

Admissible ambient temperature

0 – 55 °C

Body material

Front panel: Ultramid A3K

Body: Thin sheet DC01-A, surface yellow chromized

Weight

approx. 1.1 kg

Name plate / marking



Equipment designation	URB 2	Betriebsanleitung beachten See installation instructions Voir instructions de montage		Disposal note
Characteristics	IN/OUT: CAN-Bus 18 - 36 VDC	IP 54 (IP10) Tamb = 55°C (131°F)		Protection / Temp. rating
Output / electr.	Gerätesoftware:: 311131-XX			CE marking
Software version	Firmware: 311132-XX			
	GESTRA AG • Münchener Straße 77 • D-28215 Bremen			Manufacturer

Fig. 1

Dimensions

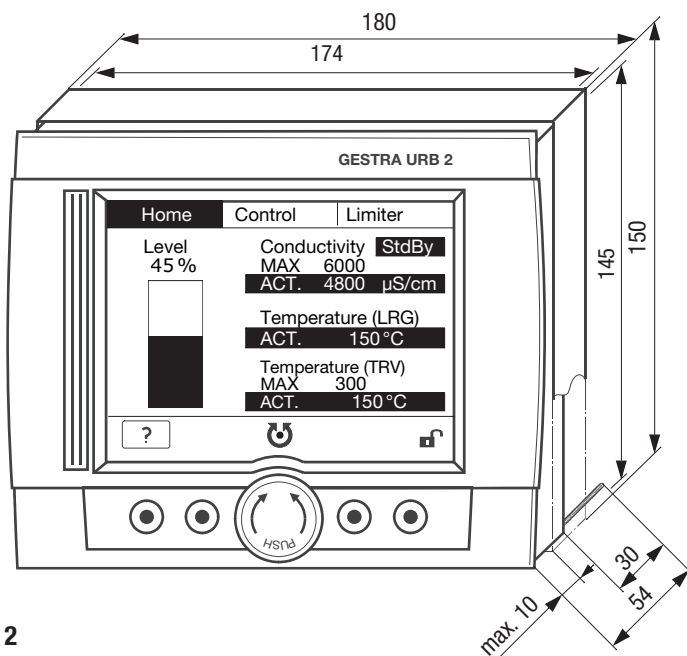

Fig. 2

Installation

URB 2

The operating and display unit URB 2 is designed for installation in control cabinets.

1. Provide cut out in control cabinet, dimensions 174 x 145 mm, max. sheet thickness 10 mm.
2. Unscrew the white fixing nuts **7** and remove the housing cover **6**. If necessary you can also unscrew the stud, but not more than 35 mm.
3. Put the operating and display unit URB 2 **4** into the cut-out, put back the housing cover **6**, screw in and tighten the fixing nuts **7**.

Functional Elements

URB 2

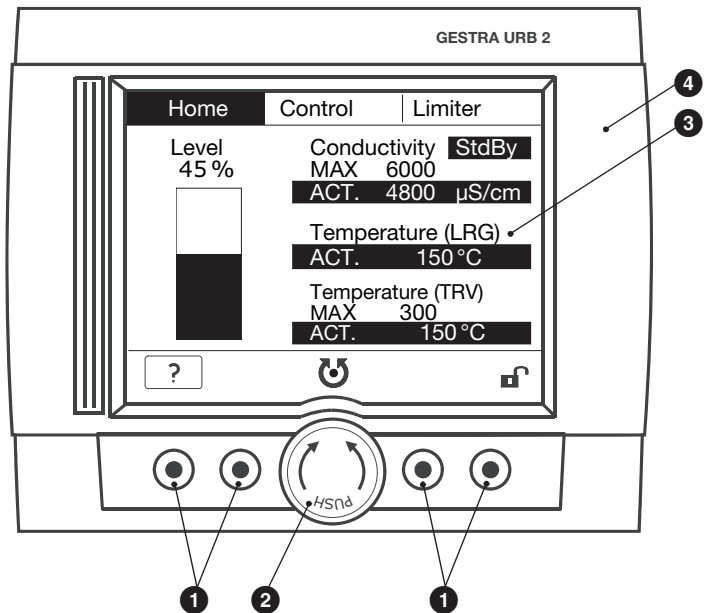

Fig. 3

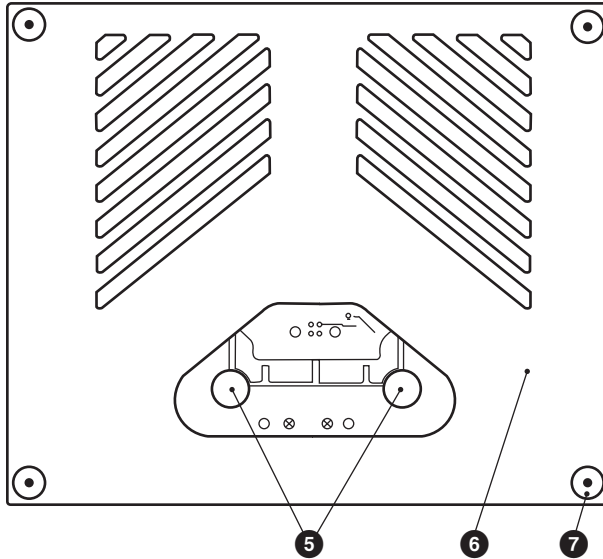

Fig. 4

Key

- 1 Pushbutton
- 2 Navigation wheel
- 3 Illuminated LCD display, resolution 320 x 240 Pixel
- 4 Frame with indicators and adjusters
- 5 Connector, 5poles
- 6 Housing cover
- 7 Fixing nuts for installation in control cabinet

Electrical Connection

Control cable

NRS, NRR, LRR, TRS, URB 1

To wire the equipment, multi-core twisted-pair control cable **must** be used for the bus line, e. g. UNITRONIC® BUS CAN 2 x 2 x ... mm² or RE-2YCYV-fl 2 x 2 x ... mm².

Control cable assemblies (2 x 2 x 0.32 mm² cable with plug and connector) of various lengths are available as add-on equipment.

NRG, LRG, EF, URZ, TRV, URB 2

The equipment is fitted with sensor plug-in connectors (5 poles, A-coded). For connecting the bus devices control cable assemblies (with plug and connector) of various lengths are available as add-on equipment.

Note that the recommended control cables are not UV-resistant and must be protected by a UV-resistant plastic tube or cable duct if the equipment is installed outdoors (except for URB 2).

The baud rate (data transfer rate) dictates the cable length and size between the bus nodes. The total power consumption must also be taken into consideration when selecting the conductor size. The total power consumption is obtained from the number of bus nodes.

If the cable length between the steam boiler and the control cabinet exceeds 15 m, we recommend that you fit a branching box that is resistant to electromagnetic interference (stock code 1501214) and use a control cable with a larger conductor size for the distance to the control cabinet.

S 8	S 9	S 10	Baud rate	Cable length	Number of pairs and conductor size [mm ²]
OFF	ON	OFF	250 kBit/s	125 m	2 x 2 x 0.32
Factory setting					
ON	ON	OFF	125 kBit/s	250 m	2 x 2 x 0.5
OFF	OFF	ON	100 kBit/s	335 m	2 x 2 x 0.75
ON	OFF	ON	50 kBit/s	500 m	on request, depending on bus configuration
OFF	ON	ON	20 kBit/s	1000 m	
ON	ON	ON	10 kBit/s	1000 m	



Note

- The max. baud rates and cable lengths indicated above are based on empirical values obtained by GESTRA. In certain cases it may be necessary to reduce the baud rate in order to ensure operational safety.
- The type and design of the data cable has a strong influence on the electromagnetic compatibility (EMC) of the equipment. Take special care when connecting the equipment.
- If you do not use the control cable assemblies connect the connectors and jacks for the control cables as indicated in the assignment diagram for sensor plug-in unions.

CAN bus voltage supply

To ensure the troublefree operation of the CAN bus system make sure that the voltage supply for all bus devices is sufficient.

Please use the following table to check the voltage supply of your bus system.

Control units with voltage supply	Qty.	X	Power output per item	=	Sum
		X	6 W	=	W
Please enter data.			Sum 1	=	W
Sensor, transmitter, control units, operating & display unit URB 1	Qty.	X	Power consumption per item	=	Sum
		X	3 W	=	W
Operating & display unit URB 2		X	5 W	=	W
	Please enter data.			Sum 2	=

If sum 2 exceeds sum 1 supply the CAN bus with 24 V DC coming from a separate and stabilized safety power supply unit (e. g. SITOP Smart 24 V 2.5 A) .

The power supply unit must be electrically isolated from dangerous contact voltages and must meet at least the requirements on double or reinforced isolation acc. to DIN EN 50178 or DIN 61010-1 or DIN EN 60730-1 or DIN EN 60950 (safe isolation).

The power supply unit must be provided with an overcurrent protective device in accordance with EN 61010-1.



Attention

If a safety power supply unit (e. g. SITOP smart, 24 V, 2.5 A) is used for the voltage supply of the CAN bus do not tap the supply voltage from the terminals 1 and 5 of the GESTRA control devices.

Wiring the connecting sockets

Wire the connecting sockets as indicated in the assignment diagram **Fig. 5**.

Wiring the sensor connectors

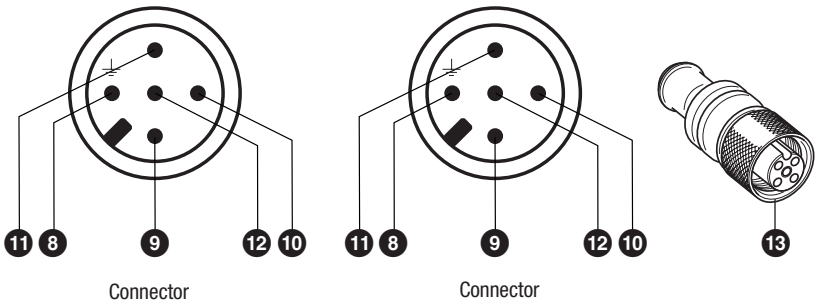

Fig. 5

Key

- 8 Pin 1: Screen
- 9 Pin 2: Power supply 24 V DC+ (red)
- 10 Pin 3: Power supply 24 V DC- (black)
- 11 Pin 4: CAN data line C_H (white)
- 12 Pin 5: CAN data line C_L (blue)
- 13 Connecting jack with terminating resistor 120 Ω

Wiring diagram for CAN bus system – example –

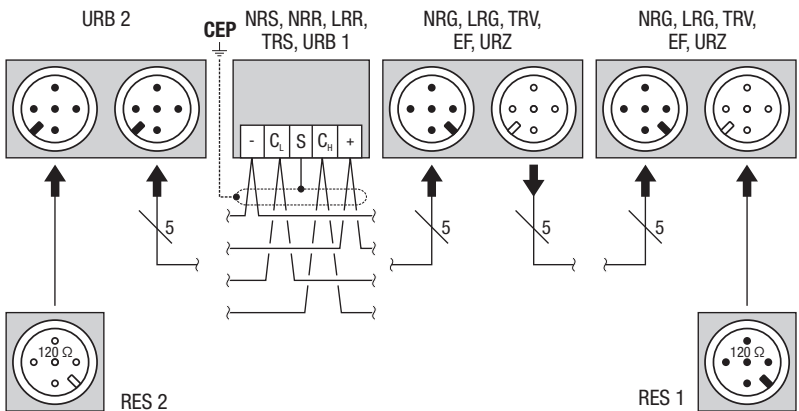

Fig. 6



Attention

- Wire equipment in series. Star-type wiring is not permitted!
- Make sure that the bus line is separated from mains and signal lines.
- Link screens of control cables such that electrical continuity is ensured and connect them **once** to the central earthing point (CEP). If equipotential bonding currents are to be expected, for instance in outdoor installations, make sure that the screen is separated from the central earthing point (CEP).
- If two or more system components are connected in a CAN bus system, provide the first and the last device with a terminating resistor of $120\ \Omega$ (terminal C_L / C_H). We recommend that you configure the URB 2 as first or last device and use the supplied connecting socket equipped with a terminating resistor for terminating the bus line.
- Note that only one operating and display unit URB 2 may be used per CAN bus network.
- The CAN bus network must not be interrupted during operation!
Note that an interruption will cause an alarm.
- The operating and display unit URB 2 must not be applied together with the operating, display & automatic control device SPECTOR*control*.

Basic Settings

Bus cable

All level, conductivity and temperature controllers and associated electrodes are interconnected by means of a CAN bus using the CANopen protocol. All devices have an electronic address – the node ID. The four-core bus cable serves as power supply and data highway for high-speed data exchange. The CAN address (node ID) can be set between 1 and 123. The operating and display unit URB 2 has already been configured at our works for operation with other GESTRA components and can be used straight away without having to set the node ID.

Factory setting

Operating & Display Unit URB 2

The operating and display unit URB 2 features the following factory set default values:

- Node ID: 60
- Baud rate: 250 kBit/s (125 m cable length)

Establishing / changing node ID

If several identical systems are to communicate in a CAN bus network, allocate a different node ID for each system (e. g. limiter, controller, etc). In most cases it is sufficient to commission the equipment with the default factory settings.

Please observe the pertinent installation instructions.

Basic Settings - continued -

Node ID

Water level limiter

NRS 1-40	NRG 16-40 (1)	NRG 16-40 (2)	Reserved	Reserved	
X	X + 1	X + 2	X + 3	X + 4	
1	2	3			Factory setting

Safety system for steam boilers with superheater

NRS 1-40.1	NRG 16-40 (1)	NRG 16-40 (2)	TRV 5-40	Limiter 4	
X	X + 1	X + 2	X + 3	X + 4	
1	2	3	4		Factory setting

Safety system (e. g. hot-water generating units)

NRS 1-40.1	NRG 16-40 (1)	NRG 16-40 (2)	Limiter 3	Limiter 4	
X	X + 1	X + 2	X + 3	X + 4	
1	2				Factory setting

Safety system (e. g. hot-water generating units)

NRS 1-40.2	TRV 5-40 (1)	TRV 5-40 (2)	Limiter 3	Limiter 4	
X	X + 1	X + 2	X + 3	X + 4	
6	7	8	9	10	Factory setting
	TRS 5-40 (1)	TRS 5-40 (2)			
	X + 1 + 90	X + 2 + 90			
	97	98			

High level alarm

NRS 1-41	NRG 16-41	Reserved	Reserved	Reserved	
X	X - 1	X + 2	X + 3	X + 4	
6	5	8	9	10	Factory setting

Further components

SRL 6-40		
X = (sensor: level limiter // hi alarm) + 2		Factory setting
ORT 6		
98		Factory setting

On-off level control

Reserved	NRS 1-42	NRG 16-42	
X - 1	X	X + 1	
19	20	21	Factory setting

Modulating level control

URZ 40	NRS 2-40	NRR 2-40	NRG 26-40	Reserved	
X - 2	X - 1	X	X + 1	X + 2	
38	39	40	41	42	Factory setting

Automatic continous blowdown control

EF 1-40	Reserved	LRR 1-40	LRG 1-4...	Reserved	
X - 2	X - 1	X	X + 1	X + 2	
48	49	50	51	52	Factory setting

Control unit

URB 1, URB 2		
60		Factory setting

Operation

User interface

The operating and display unit URB 2 shows parameters, operating conditions and other operating data. The menu can be selected and all inputs can be made by using the four pushbuttons and the navigation wheel. The operator interface of the operating and display unit URB 2 consists of four areas:

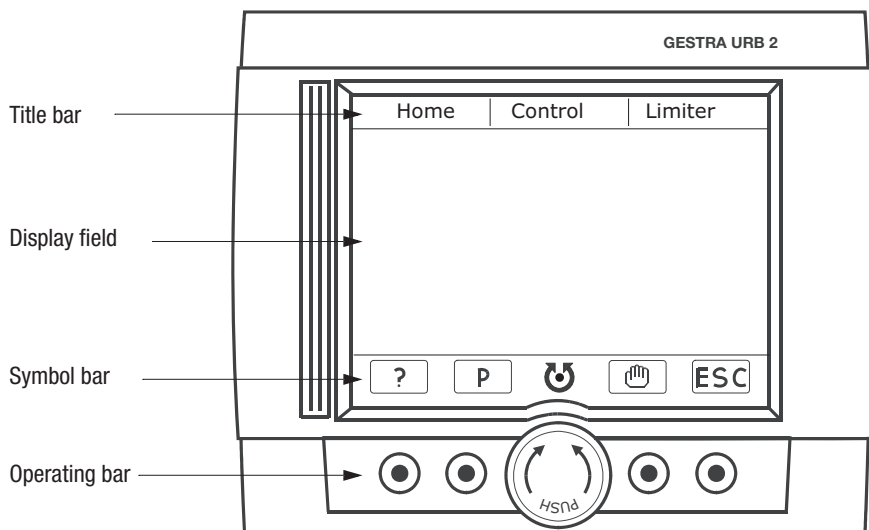

The title bar lists the menus. The selected menu is highlighted by a black background. Due to the limited space of the display not all menus can be shown.



Note

Current alarms are indicated in the title bar.
The equipment that raised the alarm is flashing.

The display field changes its appearance according to the indicated menu.

The symbol bar shows the available functions of the activated menu.

The operating bar consists of four pushbuttons and a navigation wheel. The symbol bar indicates the functions assigned to the pushbuttons and the control of the navigation wheel.



Attention

Do not press several pushbuttons at the same time or when using the navigation wheel. Incorrect data input may occur.

To ensure correct entries press the respective pushbutton or use the navigation wheel for one second.

Menus

The start window in the display shows all possible indications and readings. Note that the system configuration determines what is actually indicated.

Level controller NRR 2-40, manual operation, level 45 %

Conductivity controller LRR 1-40 , manual operation*)
 Conductivity controller LRR 1-40, stand-by operation*)

Conductivity MAX limit setting 6000 $\mu\text{S}/\text{cm}$
 Conductivity Actual value setting 4800 $\mu\text{S}/\text{cm}$
 Temperature MAX limit setting 300 °C
 Temperature Actual value 150 °C

*) Both indications at the same time are not possible during operation.

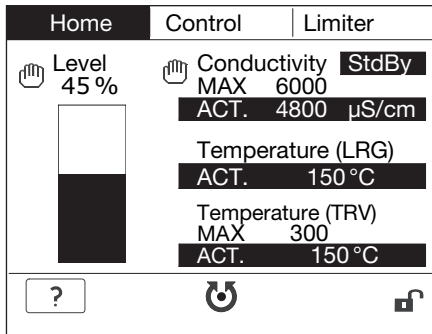

- Turn the navigation wheel to the left or to the right in order to select a menu. The selected menu is highlighted in the title bar and the overview display of the menu is indicated.
- To call up the selected menu press the navigation wheel.

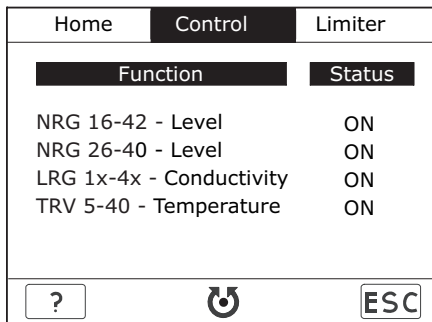

- Turn the navigation wheel to select the value to be adjusted or the equipment. The selected item is highlighted.
- Press the navigation wheel to call up the menu of the parameter or the equipment. The selected menu will be displayed.
- Only applicable for the menu Control: To select more devices repeat items 3 and 4.

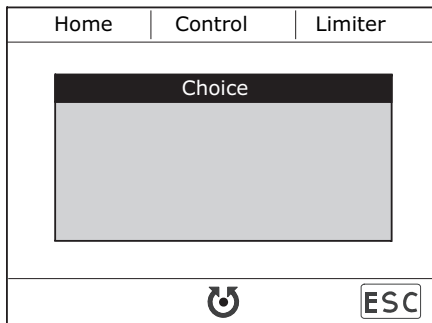

■ To quit the active menu press button **ESC**.

Specification of keys and navigation wheel

The functions allocated to the keys and the navigation wheel of the operating and display unit URB 2 depend on the activated menu. The allocation is shown in the symbol bar.



Press button  to view the associated help text in a separate menu window.

Press button  to confirm the parameter settings.



To confirm the parameter setting of values or devices press button  for approx. 1 second. If only one value can be changed in the menu, the indicator in the parameterisation mode will go directly to the value that can be adjusted.

Turn the navigation wheel to the left or to the right to select menus, devices or parameter settings. In addition, if the symbol  is shown, you can confirm this selection by pressing the navigation wheel.





To make larger modifications of the entered data more quickly use keys  and  for a fairly rough selection. Then use these keys or the navigation wheel for the subsequent fine tuning.

To activate the manual mode of the individual devices use button . The equipment will be controlled only by the operating and display unit URB 2 unless it is deactivated. The manual mode is indicated in the indicating bar of the start menu by the symbol .

The activation or deactivation of the password protection is indicated in the symbol bar of the start window by  or .







Button  has several functions. When the parameterisation mode is active it can be used to cancel the current modifications and to go back to the original setting. Furthermore it closes the active sub-menu and opens the master menu. To return to the start menu press button  several times.

Specification of the symbol bar

Key	Designation	Function
	Help	Displaying help text
	OK	Quitting the help menu / Confirming the input
	Parameter setting	Parameter setting (highlighted when activated)
	Navigation wheel	Turning the navigation wheel: Navigation between screens Switching between parameters Changing parameters
	Navigation wheel	Turning and pressing the navigation wheel: In master level: Calling up the menu In general: Confirmation Switching between parameters Changing parameters

Operation - continued -

Specification of the symbol bar - continued -

Key	Designation	Function
	Forward	Proportional increase of values
	Backward	Proportional decrease of values
	Manual operation	Manual mode (highlighted when activated)
	Disabled	Password protection is turned OFF
	Enabled	Password protection is turned ON
	Escape	Cancel input and quit menu, press the key several times to call up the start window

Menu structure

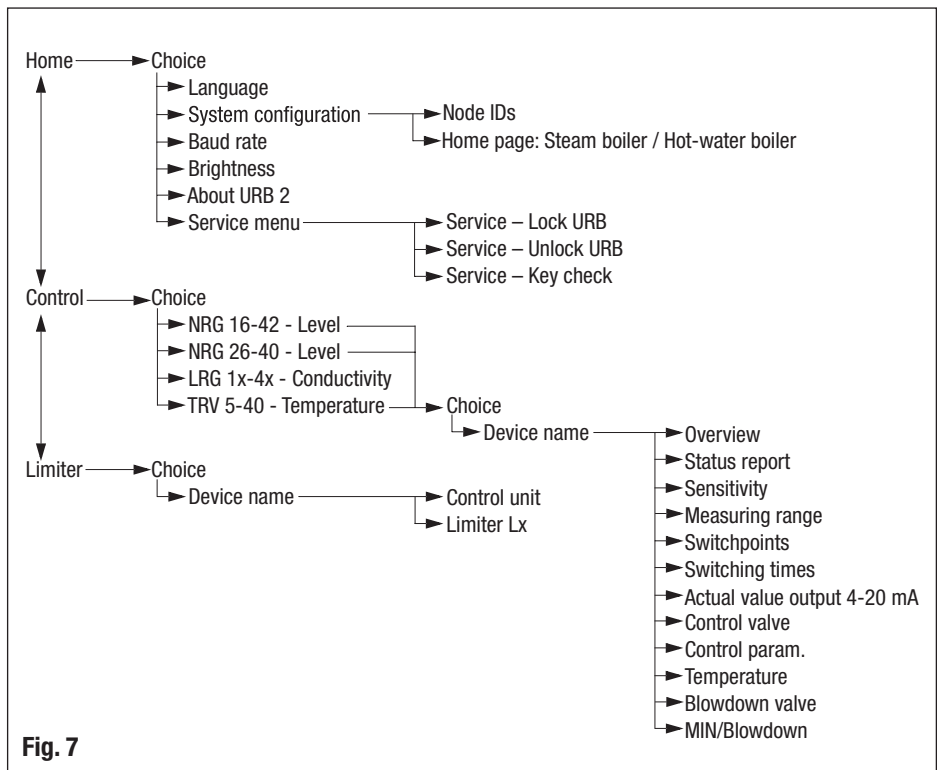

Fig. 7

Menu Start

Start logo

The start logo appears for approx. 2 minutes after restarting the equipment. During this period the parameters of the equipment connected via CAN bus are downloaded.



Start

In the menu “System configuraton” you can either select “Steam boiler” or “Hot-water boiler” as start window.

1. To select the basic settings press the navigation wheel. The selection of the menus will be indicated.

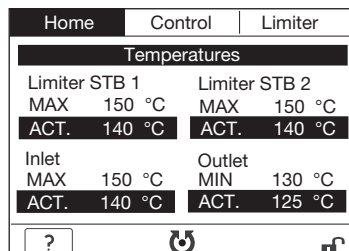
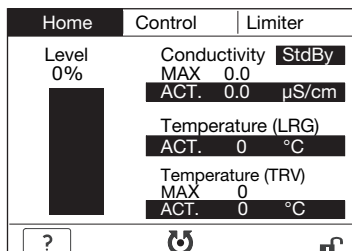

2. To select a menu turn the navigation wheel and then press it to confirm the selection.

- To choose another language select menu item Language.
- If you want to update the node IDs of the connected equipment or to activate equipment for viewing select the menu item System configuration.
- To update the baud rate select the menu item Baud rate.
- To change the properties of the display select the menu item Brightness.
- To view information on the equipment select menu item About URB 2.
- To disable equipment settings or to carry out the key test select the menu item Service menu.

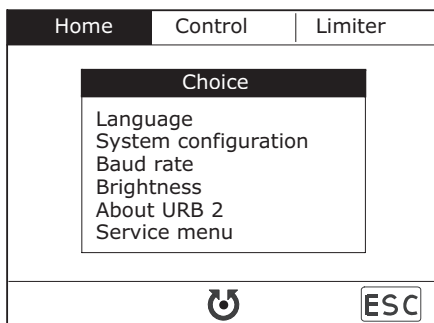

Language

- To set the parameters press button **P**.
The activated item is highlighted in the symbol bar. The background of the selected item is flashing.
- To enter a new value turn the navigation wheel and confirm the input by pressing the navigation wheel. The flashing stops.

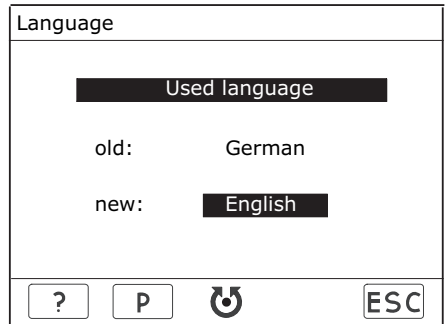

System configuration

The URB 2 is delivered with GESTRA's factory settings. Check that the node ID settings of the connected equipment agree with the factory settings (for more information see the installation manuals of the respective devices).

- Turn the navigation wheel to select the equipment group (controller, limiter, etc) to be configured.
- To set the individual parameters press button **P**.
The activated item is shown in the symbol bar.
- Turn the navigation wheel to the desired parameter and confirm the selection by pressing the navigation wheel. The background of the selected item is flashing.
- To enter a new value turn the navigation wheel and confirm the input by pressing the navigation wheel. The flashing stops.
- To obtain more available elements repeat items 3 and 4 and press button **ESC**.

System configuration		
Control (2)	Limiter	Others
NRS 1-40	001	OFF
NRS 1-41	006	OFF
NRS 1-40.1	001	ON
NRS 1-40.2	006	OFF
-----	127	OFF
-----	127	OFF

The window "Others" shows the following parameters:

- Node ID of the URB 2
- Functional selection "Steam boiler" or "Hot-water boiler"

Node ID and (de)activation of the safety temperature limiter to be displayed.

If "Steam boiler" is selected for the start window only the first safety temperature limiter can be displayed.

If "Hot-water boiler" is selected as start window two safety temperature limiters can be displayed.

System configuration		
Control (2)	Limiter	Others
URB		060
Indicated on home page:		
Function		Steam boiler
TRV - STB 1		127 OFF
TRV - STB 2		127 OFF

Baud rate

1. Check the baud rate of the connected equipment. If necessary adapt the baud rate of the URB 2 to the baud rate setting of the CAN bus.
2. To set the parameter press button **(P)**. The activated item is shown in the symbol bar. The background of the selected item is flashing.
3. To enter a new value turn the navigation wheel and confirm the input by pressing the navigation wheel. The flashing stops.

Baud rate			
Used baud rate			
old:	250kBd		
new:	125kBd		
(?)	(P)		ESC



Note

Make sure that all bus nodes feature the same baud rate settings. If a baud rate setting is incorrect an acoustic signal will be given.

Brightness

1. To set the individual parameters press button **(P)**. The activated item is shown in the symbol bar.
2. To set the desired parameter turn the navigation wheel and confirm the input by pressing the navigation wheel. The background of the selected item is flashing.
3. To enter a new value turn the navigation wheel and confirm the input by pressing the navigation wheel. The flashing stops.
4. To obtain more available elements repeat items 2 and 3 and press button **(ESC)**.

Brightness			
Background illumination			
MIN	<input type="range"/>	MAX	
Contrast of the screen			
MIN	<input type="range"/>	MAX	
(?)	(P)		ESC

Menu Start - continued -

About URB 2

To view information on the equipment select menu item About URB 2.

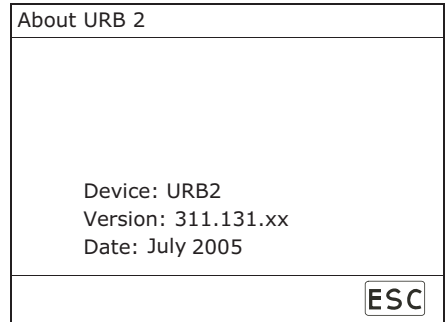

Service menu

- To disable the key functions select the menu item Lock URB.
- To enable the function of the keys select the menu item. Unlock URB.
- To check the functions of the keys select the menu Key check.

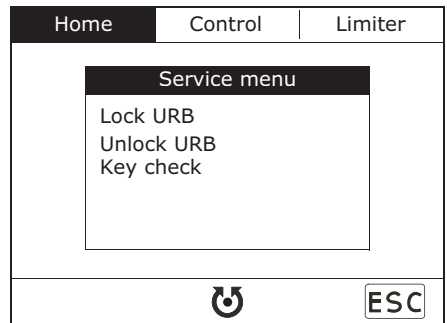

Service – Lock URB

To disable the equipment press the navigation wheel. The symbol "Equipment disabled" appears in the symbol bar of the start menu.

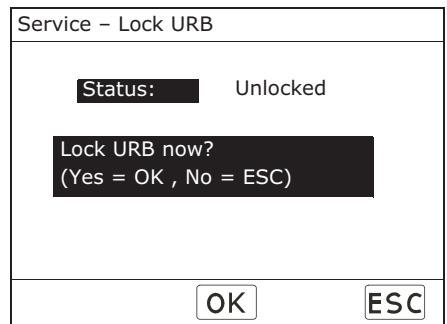

Service – Unlock URB

1. To enable the functions of the keys enter your password and press the navigation wheel.
The message whether the password is valid or invalid will be indicated.
The password is supplied separately.
2. If the password is valid press the navigation wheel to confirm the entry. The symbol  (= Equipment enabled) appears in the symbol bar of the start menu.
3. If the password is invalid enter the correct password or cancel the operation. To enter the correct password repeat items 1 and 2. Note that the equipment remains disabled if the operation is cancelled.

Service – Unlock URB		
Status:	Locked	000
<hr/>		
Wrong input:	00	
Waiting time:	00 / 03	minutes
<hr/>		
Password:	-----	
<hr/>		
1	2	OK
3	4	

Service – Unlock URB		
Status:	Locked	000
<hr/>		
W	Password is valid.	
W	Status: Unlocked	
<hr/>		
Password:	-----	
<hr/>		
OK		

Service – Unlock URB		
Status:	Locked	000
<hr/>		
W	Password is invalid!	
W	Try again ?	
W	(Yes = OK , No = ESC)	
<hr/>		
Password:	-----	
<hr/>		
OK		ESC



Note

After entering three incorrect passwords the equipment will interrupt the input function for 3 minutes.

Menu Start - continued -

Service – Key test

1. To check the function of the keys press (and hold down for some time) one key after the other. While the key is being pressed down the respective button will be highlighted in the display.
2. When the key is released the display goes back to the previous mode.
3. To check the function of the navigation wheel turn it slowly to the left and to the right. Each time an item is activated (the snapping in place is slightly perceptible) the symbol in the display changes its colour.
4. Press the navigation wheel to go to the start menu and finish the key test.

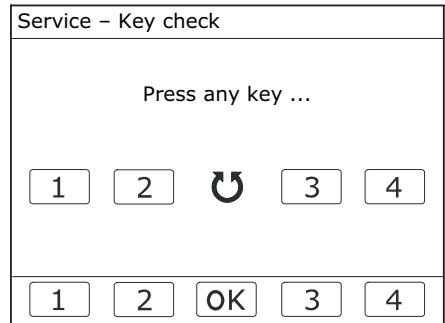

Menu Control

At a glance

	TRV 5-40 TRS 5-40	NRG 16-42 NRS 1-42	NRG 26-40 NRS 2-40	NRG 26-40 NRR 2-40	LRG 1x-4x LRR 1-40	Page
Status report	X	X	X	X	X	28
Sensitivity		X				29
Switchpoints	X		X	X		30
Proportional range				X		31
Actual value output 4-20 mA	X					31
Switching times		X	X	X		32
Measuring range			X	X		29
Control valve				X		33
Control parameters					X	34
Temperature					X	34
Continuous blowdown valve					X	35
MIN/Continuous blowdown					X	36

Control

The monitored functions together with their configuration status are indicated in the display.

1. To select the controlled variable press the navigation wheel.
The selection of the menus will be indicated.

Home	Control	Limiter
Function		Status
NRG 16-42 - Level		ON
NRG 26-40 - Level		ON
LRG 1x-4x - Conductivity		ON
TRV 5-40 - Temperature		ON
?		ESC

2. To select the desired control function turn the navigation wheel and then press it to confirm the selection.

Home	Control	Limiter
Choice		
NRG 16-42 - Level		
NRG 26-40 - Level		
LRG 1x-4x - Conductivity		
TRV 5-40 - Temperature		
		ESC

3. To select the equipment turn the navigation wheel until the desired item is marked and then press the navigation wheel.

Home	Control	Limiter
Choice		
Device name		

Overview

Concerning:

- Level control NRG 16-42 and NRS 1-42
- Level control NRG 26-40, NRS 2-40 and NRR 2-40
- Conductivity control LRG 1x-4x and LRR 1-40

The menu “Overview” shows current parameters such as the current readings and the adjusted limits.

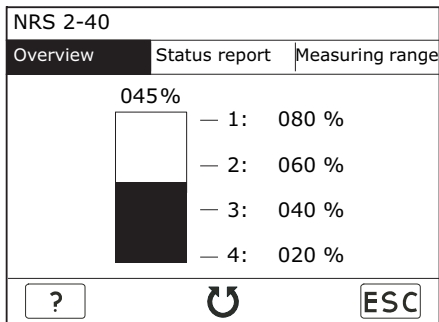

Only applicable for manual operation:

1. To operate the controllers NRR 2-40 and LRR 1-40 manually press button “Hand”. The activated item is shown in the symbol bar.
2. Turn the navigation wheel to the left or to the right to OPEN or CLOSE the valve. The opening degree of the valve is indicated and the symbol OPEN or CLOSED is flashing.
3. Press the navigation wheel to stop the valve. The flashing of the symbol stops.
4. Press button (ESC) to open the input window. Here you can choose whether the manual operation shall be deactivated and the system returns to normal operation or whether the manual operation shall be continued. If manual operation is selected the symbol “Hand” is shown in the display.

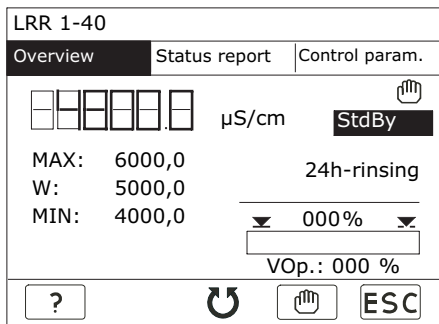
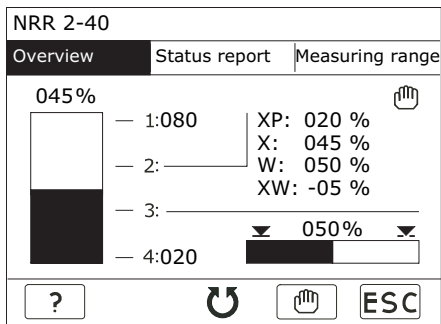

Note

When the conductivity control is switched off during stand-by operation of the boiler plant an optical signal is shown in the display. The Min/Max limits and the monitoring functions of the equipment remain active.



For more information on **stand-by operation (conductivity control)** see chapter “Glossary” on page 44.

Menu Control - continued -

Overview - continued -

Concerning:



- Temperature control TRV 5-40 and TRS 5-40

TRS 5-40 - Temperature switch		
Overview	Control	Switchpoints
Channel 1:		000 °C
Alarm:		000 °C
Channel 2:		000 °C
Control MAX:		000 °C
Control MIN:		000 °C
Alarm:		000 °C
		

Status report



Concerning:

- Level control NRG 16-42 and NRS 1-42
- Level control NRG 26-40, NRS 2-40, NRR 2-40 and URZ 40
- Conductivity control LRG 1x-4x, LRR 1-40 and EF 1-40
- Temperature control TRV 5-40 and TRS 5-40 (status message for channel 1 and 2)

Device name		
Overview	Status report	Status report (2)
Control unit	ON	
Device name:	-----	
SW version:	-----	
Status:	No errors	
Electrode	ON	
Device name:	-----	
SW version:	-----	
Status:	No errors	
		

The menu “Status Report” shows the current parameters of the equipment.

Device name		
Overview	Status report	Status report (2)
Valve	OFF	
Device name:	-----	
SW version:	-----	
Status messages:		



Note

For a full list of all status messages refer to chapter “Status messages – Control” (see page 42).

Sensitivity

Concerning:

■ Level control NRG 16-42 and NRS 1-42

1. To set the parameters press (P). The activated item is shown in the symbol bar.
2. Turn the navigation wheel until the desired value is reached. The background of the selected item is flashing.

Press the navigation wheel to confirm the selection. The flashing stops.

Device name		
Status report	Sensitivity	Switching times
Sensitivity		
0.5 $\mu\text{S}/\text{cm}$		10 $\mu\text{S}/\text{cm}$
?	P	↻
ESC		



Note

For more information on the **sensitivity (conductivity level control)** see chapter "Glossary" on page 44.

Measuring range

Concerning:

■ Level control NRG 26-40, NRS 2-40 and NRR 2-40

To calibrate the system you should use both values 0 % and 100 % of the liquid level.

Alternatively you can also calibrate the system using 0 % and a defined value, e. g. 50 % of the liquid level. In this case the value 0 % must be calibrated first.

1. To calibrate the first parameter press button (P). The activated item is shown in the symbol bar.
2. For the first calibration turn the navigation wheel to 0 % liquid level and press the navigation wheel. The background of the selected item is flashing.
3. Press the navigation wheel to confirm the selection. The flashing stops.
4. Use the navigation wheel to select 100 % liquid level or the freely adjustable liquid level and press the navigation wheel. The background of the selected item is flashing.
5. When calibrating 100 % press the navigation wheel to confirm. If a value below 100 % liquid level is used for calibration select the desired value by using the navigation wheel and press the navigation wheel to confirm your selection. The flashing stops.

Device name		
Status report	Meas. range	Switchpoints
Calibration		
— 100 %		
— ** %		
— 0 %		
?	P	↻
ESC		

Switchpoints

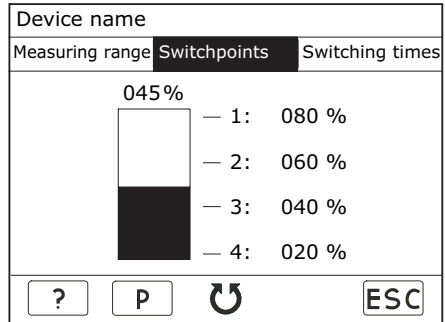

Concerning:

- Level control NRG 26-40 and NRS 2-40



Concerning:

- Temperature control TRV 5-40 and TRS 5-40

1. To set the individual parameters press button . The activated item is shown in the symbol bar.
2. To set the desired parameter turn the navigation wheel and confirm the input by pressing the navigation wheel. The background of the selected item is flashing.
3. To enter a new value turn the navigation wheel and confirm the input by pressing the navigation wheel. The flashing stops.
4. To obtain more available elements repeat items 2 and 3 and press button .

Device name	
Status report	Switchpoints
Output 4-20mA	
Channel 1:	ON
Alarm:	000 °C
Channel 2:	ON
Control MAX:	000 °C
Control MIN:	000 °C
Alarm:	000 °C
	



Note

The adjustment range of the respective switchpoint is limited by the switchpoints above or below it as well as the 0 % and 100 % (level) values or 0 °C and 650 °C (temperature).

Switchpoints, proportional range

Concerning:

■ Level control NRG 26-40 and NRR 2-40

- To set the individual parameters press button **P**. The activated item is shown in the symbol bar.
- To set the desired parameter turn the navigation wheel and confirm the input by pressing the navigation wheel. The background of the selected item is flashing.
- To enter a new value turn the navigation wheel and confirm the input by pressing the navigation wheel. The flashing stops.
- To obtain more available elements repeat items 2 and 3 and press button **ESC**.

Device name			
Measuring range	Switchpoints	Control valve	
045%	— 1: 080 %		
	— 2: 060 %		
	W:050% XP:020%		
	— 3: 040 %		
	— 4: 020 %		
?	P		ESC



Note

The adjustment range of the respective switchpoint is limited by the switchpoints above and below it as well as 0 % and 100 %.

For more information on the **proportional range X_p (capacitance level control)** refer to chapter "Glossary" on page 44.

Actual value output 4-20 mA

Concerning:

■ Temperature control TRV 5-40 and TRS 5-40

- To set the individual parameters press button **P**. The activated item is shown in the symbol bar.
- To set the desired parameter turn the navigation wheel and confirm the input by pressing the navigation wheel. The background of the selected item is flashing.
- To enter a new value turn the navigation wheel and confirm the input by pressing the navigation wheel. The flashing stops.
- To obtain more available elements repeat items 2 and 3 and press button **ESC**.

Device name		
Status report	Switchpoints	Output 4-20mA
Channel 1:		
Temperature 4mA:		000 °C
Temperature 20mA:		000 °C
Channel 2:		
Temperature 4mA:		000 °C
Temperature 20mA:		000 °C
?	P	
		ESC



Note

The adjustment range is limited to 0 - 650 °C.

Switching times

Concerning:

- Level control NRG 16-42 and NRS 1-42
- Level control NRG 26-40, NRS 2-40 and NRR 2-40

1. To set the individual parameters press button **P**. The activated item is shown in the symbol bar.
2. To set the desired parameter turn the navigation wheel and confirm the input by pressing the navigation wheel. The background of the selected item is flashing.
3. To enter a new value turn the navigation wheel and confirm the input by pressing the navigation wheel. The flashing stops.
4. To obtain more available elements repeat items 2 and 3 and press button **ESC**.

Device name		Switching times	
045%		Relay	
		0->1	1->0
— 1		03,0 s	00,0 s
— 2		00,0 s	00,0 s
— 3		00,0 s	00,0 s
— 4		03,0 s	00,0 s
?		P	ESC



Note

For more information on the switching times (**conductivity and capacitance level control**) see chapter “Glossary” on page 44.

Control valve

Concerning:

■ Level control NRG 26-40 and NRR 2-40

1. To set the individual parameters press button **(P)**. The activated item is shown in the symbol bar.
2. To select the CANopen actuator turn the navigation wheel and confirm the input by pressing the navigation wheel. The background of the selected item is flashing.
3. Turn the navigation wheel to select YES if the control valve is fitted with a CANopen actuator or NO if it is equipped with another type of actuator.
4. Press the navigation wheel. The flashing stops.
5. To calibrate the control valve turn the navigation wheel to the the first value to be adjusted.
6. Press the navigation wheel. The background of the selected item is flashing.
7. Turn the navigation wheel to the left or to the right. The valve closes or opens.
8. Press the navigation wheel for approx. 1 sec. to stop the valve. The position of the valve is shown in the display.
9. If necessary correct the valve position by turning the navigation wheel.
10. Once the desired position of the valve has been established press button **(OK)** to calibrate the equipment. The value is accepted and the flashing stops.
11. For the second calibration repeat items 5 to 10 and finish the input by pressing button **(ESC)**.
12. After the calibration procedure the current position of the control valve will be indicated in the display.

Device name		
Switchpoints	Control valve	Switching times
020%		
0% 100%		
CANopen actuator: NO		
?	P	↻
OK	ESC	



Note

For more information on the **CANopen actuator** see chapter “Glossary” on page 44.

Control parameters

Concerning:

■ Conductivity control LRG 1x-4x and LRR 1-40

1. To set the individual parameters press button . The activated item is shown in the symbol bar.
2. To set the desired parameter turn the navigation wheel and confirm the input by pressing the navigation wheel. The decimal point of the MAX, W or MIN value or the background of any other parameter setting is flashing.
3. Turn the navigation wheel until the new value is reached. Alternatively you can use button to increase the value proportionally or use button to decrease the value. Press the navigation wheel to confirm the selection. The flashing stops.
4. To obtain more available elements repeat items 2 and 3 and press button .

Device name	
Status report (2)	Control param. Temperature
Electrode:	LRG 1x-40
Unit:	µS/cm
Range:	0.5 – 500 µS/cm
MAX:	0500.0 µS/cm
W:	0000.0 µS/cm
MIN:	0000.0 µS/cm
Xp:	000 %
Hyst:	000 %



Note

For more information on **Continuous boiler blowdown, measuring range (conductivity control), proportional band X_p (conductivity control)** and **switching hysteresis Hyst (conductivity control)** see chapter “Glossary” on page 44.

Temperature

Concerning:

■ Conductivity control LRG 1x-4x and LRR 1-40

1. To set the individual parameters press button . The activated item is shown in the symbol bar.
2. To set the desired parameter turn the navigation wheel and confirm the input by pressing the navigation wheel. The background of the selected item is flashing.
3. To enter a new value turn the navigation wheel and confirm the input by pressing the navigation wheel. The flashing stops.
4. To obtain more available elements repeat items 2 and 3 and press button .

Device name	
Control param.	Temperature Blowdown valve
Compensation	OFF
TK [LINEAR]:	0.0 %/°C
TK [NORM]:	NaOH+H2O 260µS
TK [AUTO]:	Stop
Temperature:	000.0 °C
Cell constant:	0.000
Attenuation:	ON



Note



For more information on **Temperature compensation (conductivity control), TK (Linear), TK (Norm), TK (Auto), Cell constant and attenuation (conductivity control)** see chapter “Glossary” on page 44.

Continuous blowdown valve

Concerning:

■ Conductivity control LRG 1x-4x and LRR 1-40

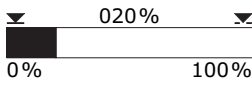
1. To set the individual parameters press button **(P)**. The activated item is shown in the symbol bar.
2. To select the CANopen actuator turn the navigation wheel and confirm the input by pressing the navigation wheel. The background of the selected item is flashing.
3. Turn the navigation wheel to select YES if the continuous blowdown valve is fitted with a CANopen actuator or NO if it is equipped with another type of actuator.
4. Press the navigation wheel. The flashing stops.
5. To calibrate the continuous blowdown valve turn the navigation wheel to the the first value to be adjusted.
6. Press the navigation wheel. The background of the selected item is flashing.
7. Turn the navigation wheel to the left or to the right. The valve closes or opens.
8. Press the navigation wheel to stop the valve. The position of the valve is shown in the display.
9. If necessary correct the valve position by turning the navigation wheel.
10. Once the desired position of the valve has been established press button **(OK)** to calibrate the equipment. The value is accepted and the flashing stops.
11. For the second calibration repeat items 5 to 10 and finish the input by pressing button **(ESC)**.
12. After the calibration procedure the current position of the continuous blowdown valve will be indicated in the display.
13. To set further parameters press button **(P)**. The activated item is highlighted in the symbol bar.
14. To set the desired parameter turn the navigation wheel and confirm the input by pressing the navigation wheel. The background of the selected item is flashing.
15. To enter a new value turn the navigation wheel and confirm the selection by pressing the navigation wheel. The flashing stops.
16. To obtain more available elements repeat items 13 to 15 or finish the input by pressing button **(ESC)**.

Device name	
Temperature	Blowdown valve MIN/Blowdown
	
Operating position: 000 %	
24h-rinsing: OFF	
CANopen actuator: NO	
(?)	(P)
	(OK) (ESC)



Note

For more information on the **operating position of the continuous blowdown valve**, **24-hour purging pulse (conductivity control)** and **CANopen actuator** see chapter "Glossary" on page 44.

MIN / Blowdown

Concerning:

■ Conductivity control LRG 1x-4x and LRR 1-40

1. To set the individual parameters press button **P**. The activated item is shown in the symbol bar.
2. To set the desired parameter turn the navigation wheel and confirm the input by pressing the navigation wheel. The background of the selected item is flashing.
3. To enter a new value turn the navigation wheel and confirm the input by pressing the navigation wheel. The flashing stops.
4. To obtain more available elements repeat items 2 and 3 and press button **ESC**.

Device name	
Temperature	Blowdown valve MIN/Blowdown
Relay 4:	
MIN alarm	Blowdown
Blowdown interval:	001 h
Blowdown time:	03 s
Blowdown pulse:	02
Pulse interval:	05 s
?	P  ESC



Note

For more information on **Continuous Blowdown** see chapter “Glossary” on page 44.

Menu Limiter

Limiter

The monitored equipment together with their configuration status are indicated in the display.

1. To select the equipment press the navigation wheel. The selection of the menus will be indicated.

Home	Control	Limiter
Device		Configuration
NRS 1-40	ON	B1 B2
NRS 1-41	ON	B1
NRS 1-40.1	ON	B1 B2 B3 B4
NRS 1-40.2	ON	B5 B6 B7 B8
?		
		ESC

2. To select the desired limiter turn the navigation wheel and then press it to confirm the selection.

Home	Control	Limiter
Choice		
Device name		
		
		ESC









Note

The control units NRS 1-40 and NRS 1-40.1 must not be used together in one CAN bus system.

Menu Limiter - continued -

Control unit

1. To switch the display on or off press button .
Button  in the symbol bar is highlighted.
The background of ON or OFF is flashing.
2. Turn the navigation wheel to ON or OFF.
Press the navigation wheel, the flashigh will stop.
The display is switched on or off.



Device name	
Control unit	Limiter L1 Limiter L2
Control unit	OFF
Device name:	-----
SW version:	-----
Alarm:	-----
Status message:	
No errors	
	  







Note

For a full list of all status messages refer to chapter "Status messages – Limiter" (see page 39).

Limiter Bx

1. To switch the display on or off press button .
Button  in the symbol bar is highlighted.
The background of ON or OFF is flashing.
2. Turn the navigation wheel to ON or OFF.
Press the navigation wheel, the flashigh will stop.
The display is switched on or off.
3. Limiters that are switched on are shown in the list "Limiters".

Device name	
Control unit	Limiter L1 Limiter L2
Limiter L1	OFF
Device name:	-----
SW version:	-----
Alarm:	-----
Status messages:	

Testing the limiter

Press and hold down button . Limiters (control units) must respond as if the alarm was real.



Note

To ensure a quick search for malfunctions we recommend that all available limiters are switched ON.

Should a malfunction occur check the plausibility of the system configuration.

System Malfunctions

Causes

Malfunctions occur if CAN bus components have been mounted or configured incorrectly or if electronic component parts are defective, or in the event of excessive heat in the equipment or electrical interference in the supply system.

Further malfunctions are:

- Faulty communication in CAN bus system
- 24V PSU in control unit overloaded.



Note

Before carrying out the systematic fault finding procedure please check:

Wiring:

Is the wiring in accordance with the wiring diagrams?

Is the polarity correct throughout the whole bus line?

Is the bus line of each of the end nodes provided with a 120 Ω terminating resistor?

Node ID:

Are all node IDs set correctly?

Do not use a node ID twice!

Baud rate:

Is the length of the cable in accordance with the adjusted baud rate?

(The URB 2 gives an acoustic signal if the baud rate setting is incorrect.)

Is the baud rate the same for all devices?



Attention

For more information on system malfunctions refer to the installation manuals of the connected equipment.

Systematic malfunction analysis

The sources of malfunctions occurring in CAN bus systems operating with several bus-based stations must be analysed systematically since faulty components or incorrect settings can give rise to negative interactions with intact bus devices in the CAN bus system. These unwanted interactions can cause error messages in fully functional bus devices, which will make fault detection even more difficult.

We recommend the following systematic fault finding procedure:

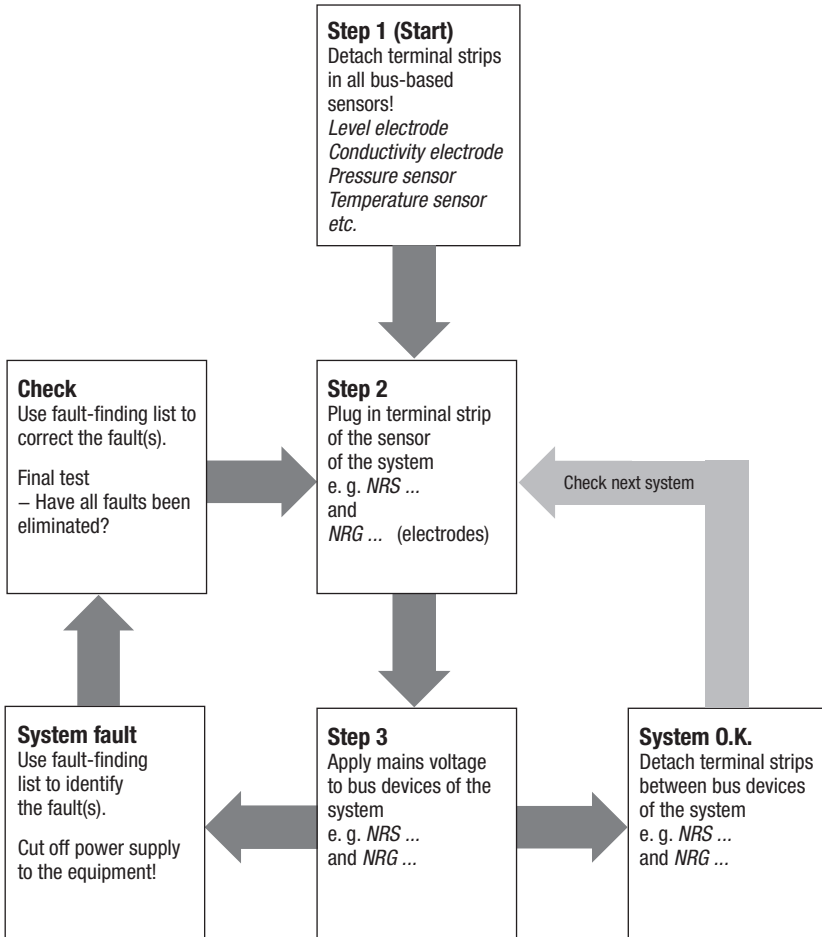

Restart

1. Press the navigation wheel to restart the system.
2. After the restart the start window will be displayed.

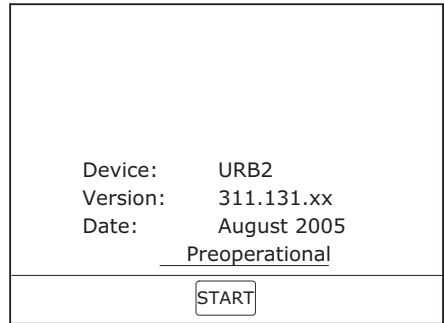

Note

All values indicated by the URB 2 will be updated within 2 minutes.



Attention

If it is not possible to restart the system automatically interrupt the voltage supply (unplug the connecting socket). After approx. 5 minutes re-commission the URB 2 in accordance with the installation instructions.

System malfunctions - continued -

Status messages

Control	TRV 5-40	TRS 5-40	NRS 1-42	NRG 16-42	NRS 2-40	NRR 2-40	NRG 26-40	LRR 1-40	LRG 1x-4x
No communication	X	X	X	X	X	X	X	X	X
Collective bit channel 1 and 2		X							
T MAX exceeded	X	X	X	X	X	X	X	X	X
Plausibility error			X	X					
Electrode lost			X		X	X		X	
Electrode defective									X
PT 1000 defective									X
Sensor defective	X								
A/D converter	X								

Limiter	TRV 5-40	NRS 1-4x	NRG 1x-4x
Faulty communication		X	
No communication	X	X	X
Collective bit, self-checking routine	X	X	X
T MAX exceeded	X		X

Blowdown/control valve	EF 1-40, URZ 40
230 V not available	X
Calibration error	X
Temperature error	X
Potentiometer error	X
Actuator blocked	X
End position plausibility	X
Time Out (valve can no longer receive control telegrams)	X



Note

The system message "T MAX exceeded" is given when the ambient temperature is excessively high. Note that the temperature of the boiler is not monitored.

If faults occur that are not listed above or cannot be corrected, please contact our service centre or authorized agency in your country.

Decommissioning

URB 2

First cut off power supply to the operating and visual display unit URB 2 and then remove the connecting socket. De-install the operating and display unit.

Disposal

Dismantle the operating and display unit and separate the waste materials, using the specifications in the table "Materials" as a reference. Electronic component parts such as the circuit board must be disposed of separately! For the disposal of the control unit observe the pertinent legal regulations concerning waste disposal.

Glossary

Continuous boiler blowdown (top blowdown)

As the boiler water evaporates, the concentration of non-volatile dissolved solids (TDS) left behind in the boiler increases over time as a function of steam consumption. If the TDS (= total dissolved solids) concentration exceeds the limit defined by the boiler manufacturer, foaming and priming occurs as the density of the boiler water increases, resulting in a carry-over of solids with vapor into steam lines and superheaters. As a result the operational safety is impaired and the steam boiler and/or pipelines can be damaged. To keep the TDS concentration within admissible limits, a certain portion of boiler water must be removed continuously or periodically (by means of a blowdown valve) and fresh make-up water must be added to the boiler feed to compensate for the water lost through blowdown.

Intermittent boiler blowdown (bottom blowdown)

During the evaporation process fine sludge deposits settle on heating surfaces and in the lowest part of the steam boiler. The accumulated sludge sediments form a thermally insulating layer and can damage the boiler walls due to excessive heat. The resulting suction effect occurs only at the moment when the valve is being opened, the opening time should therefore not exceed 2 seconds. The timed pulse/interval control of the intermittent blowdown valve optimises sludge removal while minimising loss of boiler water. The interval between the intermittent blowdown pulses can be set between 1 and 120 h (**intermittent blowdown interval**). The **duration of the intermittent blowdown** can be set between 1 and 60 s. For larger boilers it may be necessary to repeat the intermittent blowdown pulses. The **intermittent blowdown pulses** can be repeated up to 5 times within 5 - 30 seconds (**pulse interval**).

Sensitivity (conductivity level control)

The level electrode NRG 16-42 works only when used in water with a minimum electrical conductivity. If the electrical conductivity of the boiler water is $< 10 \mu\text{S/cm}$ at 25°C set the sensitivity to $0.5 \mu\text{S/cm}$.

Operating position of the continuous blowdown valve

It is common practice to use the continuous blowdown valve to remove water from the boiler in order to keep the TDS level within certain predefined limits. This means that the valve must be permanently open so that a steady flow of water is ensured (the valve is in the operating position). The operating position is adjustable between 0 and 25 %. For the corresponding amount of boiler blowdown refer to the capacity charts of the continuous blowdown valve.

CANopen actuator

The continuous blowdown valve and/or the control valve is equipped with a CANopen actuator. See installation manual EF 1-40 / URZ 40.

Attenuation (conductivity control)

The presence of steam bubbles can lead to greatly fluctuating conductivity readings. An attenuator will damp the oscillations in the measurements.

Measuring range (conductivity control)

The measuring range setting establishes the actual value output 4-20 mA of the control equipment LRR 1-40.

Proportional band X_p (conductivity control)

If the controller is to work as a proportional controller, the proportional band can be set between 1 and 150 %. It refers to the adjusted setpoint w . If $X_p = 0$ is set, the controller is configured as two-position controller.

Proportional band X_p (capacitance level control)

Switchpoint 2 marks the upper limit and switchpoint 3 the lower limit of the proportional band. The difference between switchpoint 2 and switchpoint 3 gives the magnitude of the proportional range X_p .

Switching hysteresis Hyst (conductivity control)

If $X_p = 0$ is set, the controller is configured as 2-position controller, which means that the valve will open if there is a positive deviation ($X > w$). The conductivity must then decrease until a new value that is lower than the setpoint minus the adjusted hysteresis is reached. Once this value is reached the valve will be motored into the operating position.

Switching times (conductivity and capacitance level control):

For each of the four output relays individual time delays for energizing and de-energizing can be set.

Stand-by mode (conductivity control)

To avoid loss of water, the continuous blowdown control and the programme-controllerd intermittent boiler blowdown (if activated) can be de-activated during stand-by operation or when the burner is switched off. An external control command will be triggered and, as a result, the continuous blowdown valve will be closed. During stand-by operation the MIN/MAX limits and the monitoring function remain active. After the equipment switches back to normal operation the continuous blowdown valve is motored into the OPERATING position or the control position. In addition an intermittent blowdown pulse is triggered off (provided that automatic intermittent boiler blowdown has been activated and an interval period and pulse duration have been set).

Temperature compensation (conductivity control)

The electrical conductivity changes as the temperature falls or rises. To obtain meaningful readings it is therefore necessary that the measurements are based on the reference temperature of 25 °C and that the measured conductivity values are corrected by the temperature coefficient factor α (Tk). For automatic temperature compensation the following three settings are available: TK Linear, TK Norm or TK Auto.

TK (Linear):

To ensure that the readings are based on 25 °C set the TK value between 0 and 3.0 %/°C (default setting 2.1 %/°C). This setting permits the linear temperature compensation of the measured value over the whole measuring range. This method is usually applied for steam boilers operating at constant service pressure. After the TK is set and the service pressure is reached use a calibrated conductivity meter to measure the conductivity of the boiler water and compare the reading with the indicated conductivity value. If the reading differs from the indicated conductivity change the TK setting until they tally.

TK (Norm)

Since conductivity is not a linear function of temperature over a larger temperature range, various conditioning agents and different basic conductivities were used in order to ascertain empirical conductivity/temperature curves. These curves are stored as standard curves and can be used for temperature compensation. TK (NORM) is suitable for boilers operating with variable pressure, which means that the boiler does not have a fixed working pressure (e. g. low load 10 bar, full load 15 bar).

TK (Auto)

For this method a characteristic conductivity/temperature curve of the plant (Auto curve) is used for temperature compensation. However, first a characteristic Auto curve must be recorded. For this purpose turn the navigation wheel at TK (AUTO) to start and then press the navigation wheel in order to start recording the curve. Apply the max. service pressure to the steam boiler. During the heating process every 100 °C above 10 °C temperature and conductivity values are recorded and the current temperature is indicated. After having recorded 25 values or if STOP is selected the equipment stops recording and saves the Auto curve. TK (AUTO) is suitable for steam boilers operating with variable pressures. When the compensation is switched OFF the absolute conductivity will be indicated.

Cell constant (conductivity control)

The cell constant is a geometric quantity characteristic of the level electrode and is taken into account when calculating the conductivity. However, in the course of time this constant may change, e. g. due to dirt deposits accumulated on the measuring electrode.

If a reference measurement yields a result that differs from the indicated conductivity value check the temperature compensation first. Only if the the temperature coefficient setting is no longer sufficient for a correct compensation should you modify the cell constant. In this case change the cell constant until the reading and the indicated conductivity agree.

24 hour purging pulse (conductivity control)

To prevent blocking of the continuous blowdown valve a purging pulse is triggered when the mains voltage is switched on. The continuous blowdown valve is actuated and opens for 2 minutes. After this period the valve is motored into the CLOSED position where it remains for 2 minutes. Then the valve is motored into the OPERATING position or into the required control position. This process is repeated every 24 hours. During stand-by operation the time interval continues without triggering off the purging pulse. Note that during the purging process the MIN limit is not active. The 24 hour purging pulse can be switched ON or OFF.

For your notes



Agencies all over the world: www.gestra.de

GESTRA AG

Münchener Straße 77

28215 Bremen

Germany

Telefon +49 421 3503-0

Telefax +49 421 3503-393

E-mail info@de.gestra.com

Web www.gestra.de